

Top profile  
type 251  
Galv 1,0 mm

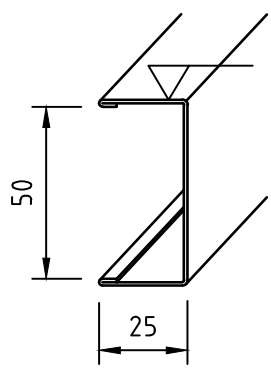

Connection profile  
type 452

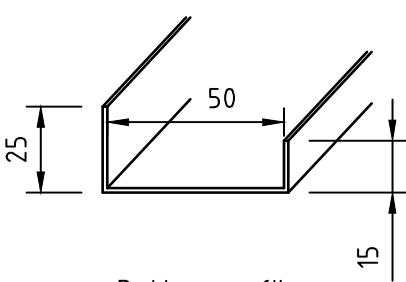

Bottom profile  
type 151  
Galv 1,25 mm

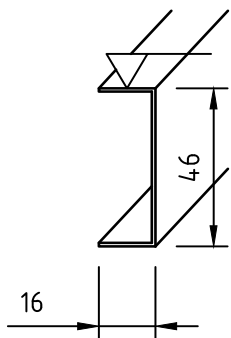

Connection profile  
type 451

PVC or painted  
thickness 0,6 mm

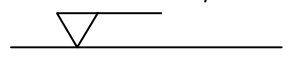

**JMC 1 38 B-15**  
**JMC 1 42 B-15**  
**JMC 1 44 B-15**



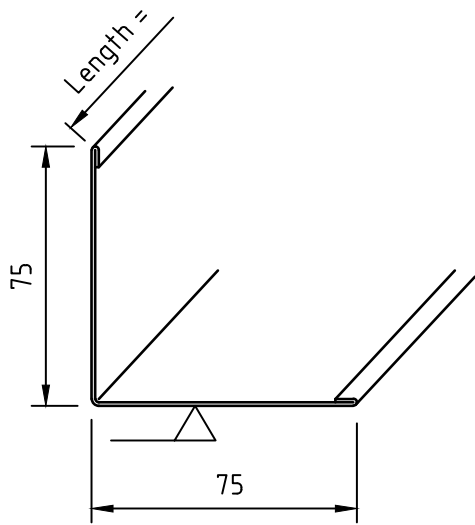
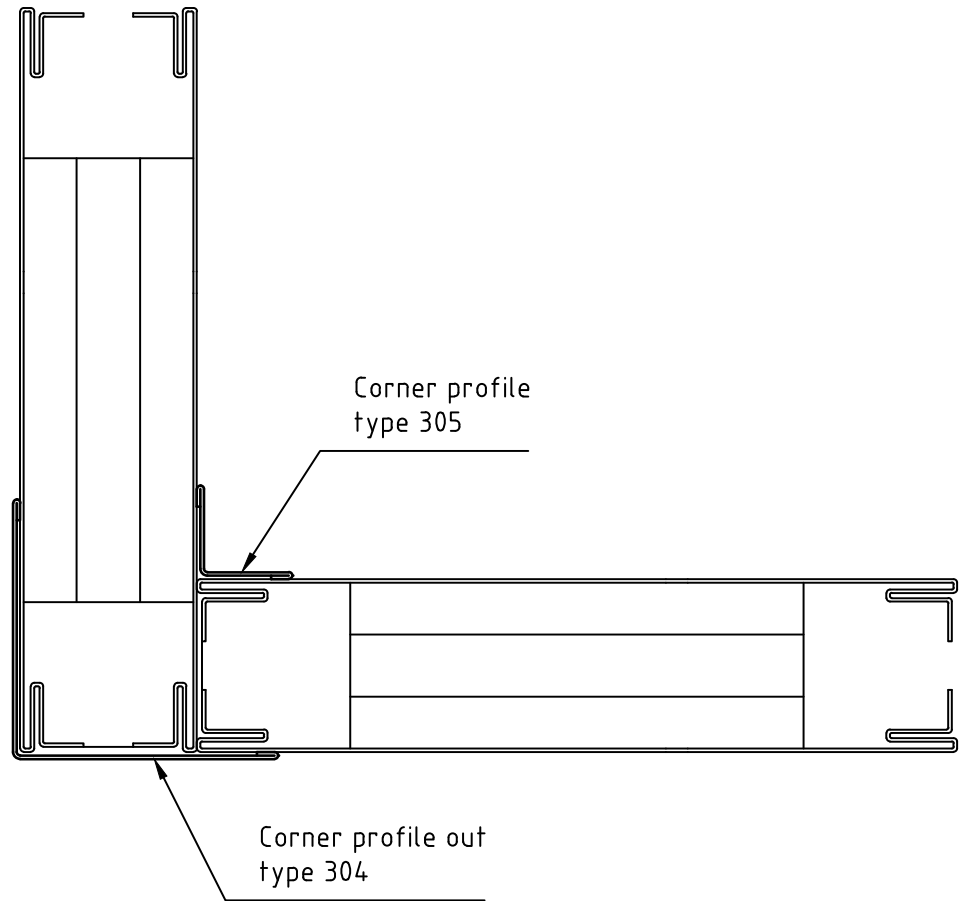

Corner profile out  
type 304

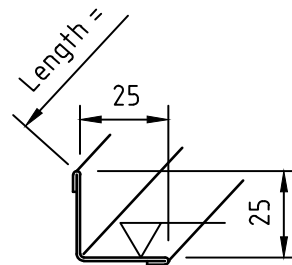

Corner profile in  
type 305

PVC or painted  
thickness 0,6 mm

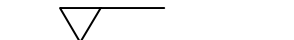

JMC 1 38 B-15  
JMC 1 42 B-15  
JMC 1 44 B-15  
Corner profiles

**SBA** INTERIOR

Page  
2