

Top profile
type 251
Galv 1,0 mm

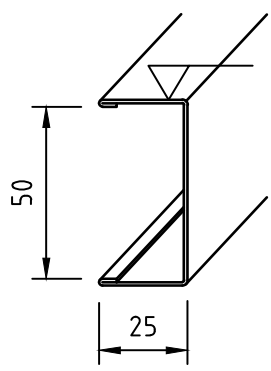

Connection profile
type 452

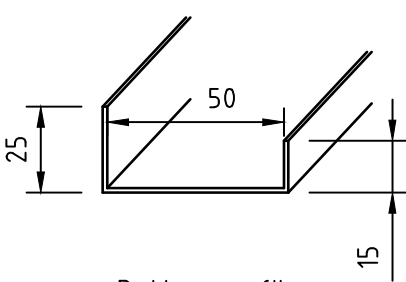

Bottom profile
type 151
Galv 1,25 mm

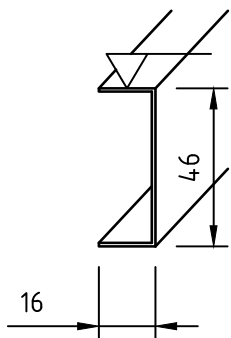

Connection profile
type 451

PVC or painted
thickness 0,6 mm

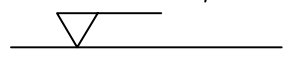

JMC 1 38 B-15
JMC 1 42 B-15
JMC 1 44 B-15



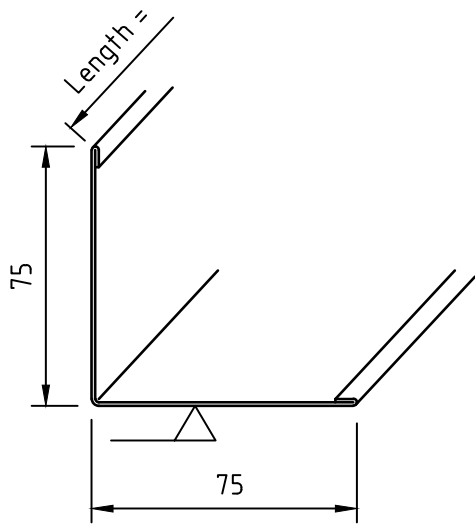
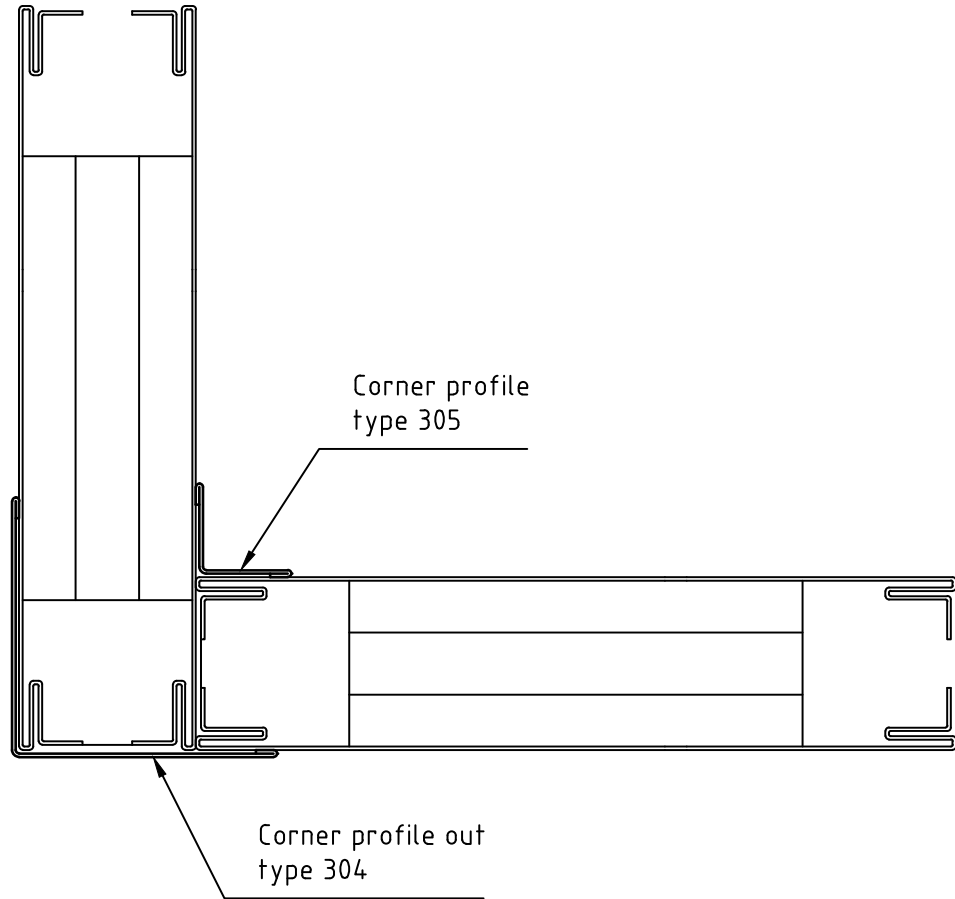

Corner profile out type 304

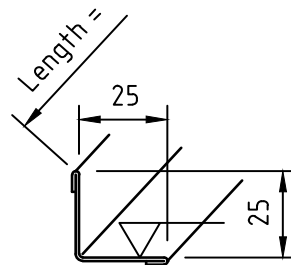

Corner profile in type 305

PVC or painted
thickness 0,6 mm



JMC 1 38 B-15
JMC 1 42 B-15
JMC 1 44 B-15
Corner profiles

SBA INTERIOR

Page
2